

It all hinges on excellence.

SIMONSWERK



BILOBA

The self-closing screw-on
hinge system for glass doors

Content

BILOBA – the self-closing screw-on hinge system for glass doors

Double action door

06	BL 8010	100 kg	Wall-glass central fixing for residential and heavy-duty glass doors
07	BL 8010 SF		for residential and heavy-duty glass doors without stop
08	BL 8010 SOL		for residential and heavy-duty glass doors without self-closing function
09	BL 8010 BT JC		for residential, heavy-duty and shower glass doors with zero point adjustability
10	BL 8010 BT JC C		for use with BL 8010 BT JC
11	BL 8910		for residential and heavy-duty glass doors with zero point adjustability
			Wall-glass offset fixing
12	BL 8011	100 kg	for residential and heavy-duty glass doors
13	BL 8011 SF		for residential and heavy-duty glass doors without stop
14	BL 8011 SOL		for residential and heavy-duty glass doors without self-closing function
15	BL 8911		for residential and heavy-duty glass doors with zero point adjustability
			Glass-glass central fixing
16	BL 8015	80 kg	for residential glass doors
17	BL 8015 SF		for residential glass doors without stop
18	BL 8015 SOL		for residential glass doors without self-closing function
19	BL 8015 BT JC		for residential and shower glass doors with zero point adjustability
20	BL 8015 BT JC C		for use with BL 8015 BT JC
21	BL 8915		for residential glass doors with zero point adjustability

Single action door

			Wall-glass central fixing
22	BL 8060	100 kg	for residential and heavy-duty glass doors
23	BL 8060 SF		for residential and heavy-duty glass doors without stop
			Wall-glass offset fixing
24	BL 8060 SOL	100 kg	for residential and heavy-duty glass doors
25	BL 8060 BT		for shower glass doors
26	BL 8060 BT SF		for shower glass doors without stop

28 **Finishes**

29 Service

BILOBA – the self-closing screw-on hinge system for glass doors

Architecture is diverse – all the better when door hinges with a classic look fit effortlessly into any concept. Thanks to an individual, aesthetically high-quality design, BILOBA is such an adaptable door hinge. The screw-on hinge system for double- and single-action doors has an automatic self-closing function thanks to integrated hydraulic damping. It is internationally patented and tested in over one million opening cycles. The adjustable closing speed enables ideal adaptability to user needs. Therefore the classic door hinge is equally at home in office and administrative buildings as in showrooms, museums or sophisticated restaurants.

BILOBA – the advantages at a glance

- for indoor use and outdoor areas that are protected from driving rain
- high load capacities possible
- hydraulic hinge system
- adjustable closing speed
- constant damping control
- opening angle up to 180°



Perfect support for transparent room concepts

BILOBA screw-on hinges open up maximum comfort: The doors are effortlessly opened manually and close automatically at the set speed.

The patented technical concept

The integrated hydraulic damping system ensures a smooth and controlled closing process. The doors can be realized with door push handles or with suitable latch lock and counter box. The latch of the lock is quietly and safely pulled into the strike plate which prevents damage to the glass, door hinges and lock, as well as noise pollution. A continuous adjustment on the hinge allows the individual adjustment of the closing speed to any door weight, any door width and the walking speed of the user.

Rich finishes for a successful staging

BILOBA is versatile in every respect: Central or offset glass-wall installation is possible. As a glass-glass version with central fixing, the hinge supports transparent room concepts, for example in offices. In addition, there are various high-quality finishes to choose from.



BILOBA

BL 8010

with central fixing (wall-glass) for double action residential and heavy-duty glass doors

hydraulic hinge double action door up to 100 kg

Product features

- hydraulic hinge
- for use with wall-glass combinations
- with closing speed adjustment
- stop at +90° and -90°
- automatic closing from +80° and -80°
- can also be used for single action doors

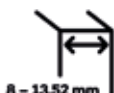
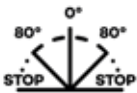

Technical details

load capacity	100.0 kg
opening angle	+/- 90°
hold open	+/- 90°
automatic closing	+/- 80°
glass thickness	8-13.52 mm
temperature resistance	- 15.0 °C to + 40.0 °C
max. door width	1000.0 mm

Finish

EV1 satin silver natural, anodized 20 micron (CO 002), satin black anodized (CO 005), imitation satin stainless steel (CO 013), polished Chrome (CO 014), imitation matt chrome liquid electrostatic coated (CO 015), polished gold (CO 016), matt gold (CO 017), RAL 9005 matt liquid electrostatic coated (CO 062), RAL 9010 matt liquid electrostatic coated (CO 088), RAL 9016 matt liquid electrostatic coated (CO 095)

Combination

BL 8010 SF, BL 8010 SOL

Note

i Violent opening further than 95° could unhinge the door. We suggest to install a door stop. For doors with width less than 500 mm use item BL 8010 + BL 8010 SOL. Covers in matt stainless steel and polished stainless steel available on request.

Classification key

EN 1154

3	8	2/5*1	0	1	4
---	---	-------	---	---	---

*1 Please refer to the notes and explanations on page 27.

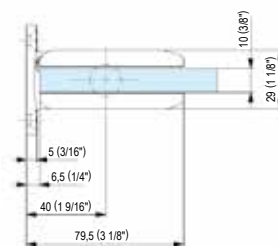
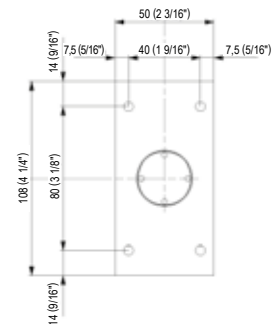
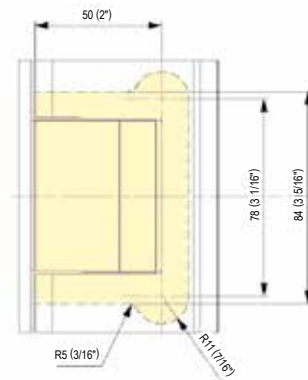

Adjustment valve for the door's closing speed

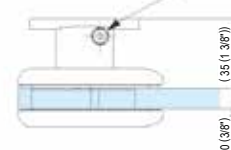

BILOBA

BL 8010 SF

with central fixing (wall-glass) for double action residential and heavy-duty glass doors without stop



hydraulic hinge	double action door	up to 100 kg
-----------------	--------------------	--------------

Product features

- hydraulic hinge
- for use with wall-glass combinations
- with closing speed adjustment
- automatic closing from +80° and -80°
- can also be used for single action doors

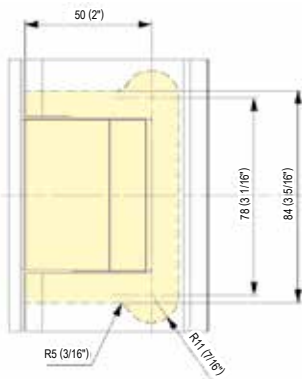

Technical details

load capacity	100.0 kg
opening angle	+/- 90°
automatic closing	+/- 80°
glass thickness	8-13.52 mm
temperature resistance	- 15.0 °C to + 40.0 °C
max. door width	1000.0 mm

Finish

EV1 satin silver natural, anodized 20 micron (CO 002), satin black anodized (CO 005), imitation satin stainless steel (CO 013), polished Chrome (CO 014), imitation matt chrome liquid electrostatic coated (CO 015), polished gold (CO 016), matt gold (CO 017), RAL 9005 matt liquid electrostatic coated (CO 062), RAL 9010 matt liquid electrostatic coated (CO 088), RAL 9016 matt liquid electrostatic coated (CO 095)

Combination

BL 8010

Note

i Violent opening further than 95° could unhinge the door. We suggest to install a door stop. Covers in matt stainless steel and polished stainless steel available on request.

Classification key

EN 1154

3	8	2/5*1	0	1	4
---	---	-------	---	---	---

*1 Please refer to the notes and explanations on page 27.

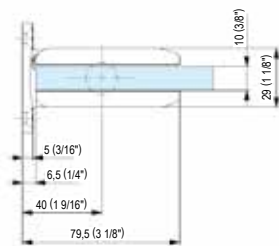
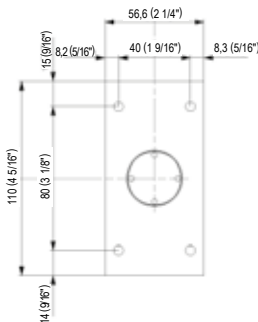

Adjustment valve for the door's closing speed

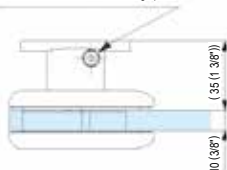

BILOBA

BL 8010 SOL

with central fixing (wall-glass) for double action residential and heavy-duty glass doors

free hinge double action door up to 100 kg

Product features

- free hinge
- for use with wall-glass combinations
- can also be used for single action doors

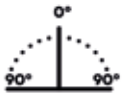

Technical details

load capacity	100.0 kg
opening angle	+/- 90°
thickness	8-13.52 mm
max. door width	1000.0 mm

Finish

EV1 satin silver natural, anodized 20 micron (CO 002), satin black anodized (CO 005), imitation satin stainless steel (CO 013), polished Chrome (CO 014), imitation matt chrome liquid electrostatic coated (CO 015), polished gold (CO 016), matt gold (CO 017), RAL 9005 matt liquid electrostatic coated (CO 062), RAL 9010 matt liquid electrostatic coated (CO 088), RAL 9016 matt liquid electrostatic coated (CO 095)

Combination

BL 8010

Note

i Covers in matt stainless steel and polished stainless steel available on request.

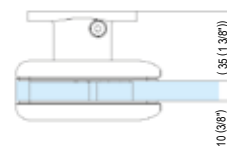
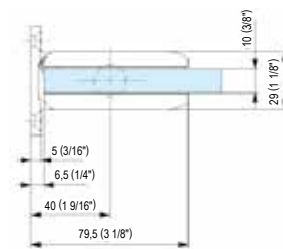
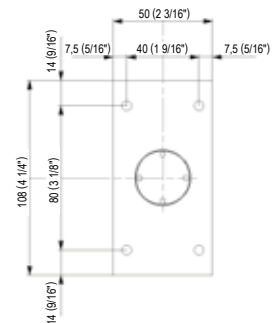
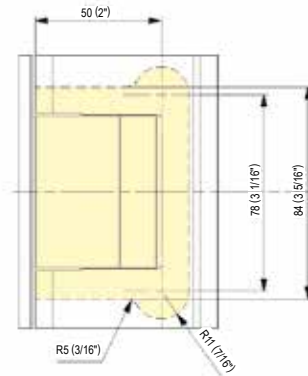

BILOBA

BL 8010 BT JC

with central fixing (wall-glass) for double action residential, heavy-duty and shower glass doors with zero point adjustability

hydraulic hinge	double action door	up to 100 kg
-----------------	--------------------	--------------

Product features

- hydraulic hinge
- for use with wall-glass combinations
- with closing speed adjustment
- with zero point adjustment
- inner body anodized with special deep oxidation (20 micron)
- stop at +90° and -90°
- automatic closing from +80° and -80°
- version without covers

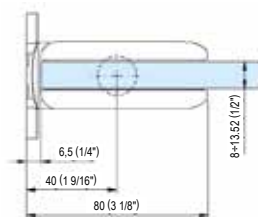
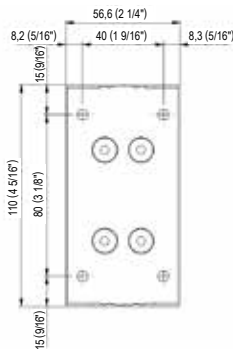
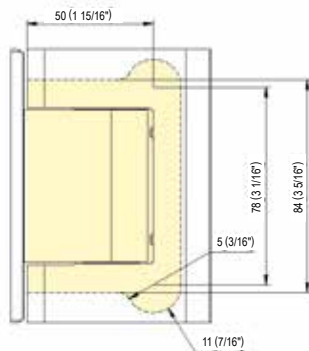
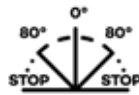

Adjustment valve for the door's closing speed

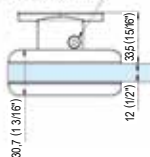

Technical details

load capacity	100.0 kg
opening angle	+/- 90°
hold open	+/- 90°
automatic closing	+/- 80°
glass thickness	8-13.52 mm
temperature resistance	- 15.0 °C to + 100.0 °C
max. door width	1000.0 mm

Finish

raw (CO 000)

Combination

BL 8010 BT JC C

Note

i Violent opening further than 95° could unhinge the door. We suggest to install a door stop. No Anti-Wind brake. For doors with width less than 500 mm use items BL 8010 BT JC + BL 8010 BT JC SOL. Covers to be ordered separately.

Classification key

EN 1154

3	8	2/5*1	0	1	4
---	---	-------	---	---	---

*1 Please refer to the notes and explanations on page 27.

Quality marks



BILOBA

BL 8010 BT JC C

for use with BL 8010 BT JC

cover

Product features

- pair of decorative covers
 - for use with BL 8010 BT JC
-

Finish

polished Chrome (CO 014), brushed stainless steel (CO 031), polished stainless steel (CO 032), RAL 9005 matt liquid electrostatic coated (CO 062)

Combination

BL 8010 BT JC



BILOBA

BL 8910

with central fixing (wall-glass) for double action residential and heavy-duty glass doors

hydraulic hinge	double action door	up to 100 kg
-----------------	--------------------	--------------

Product features

- hydraulic hinge
- for use with wall-glass combinations
- with closing speed adjustment
- with zero point adjustment
- stop at +90° and -90°
- automatic closing from +80° and -80°
- can also be used for single action doors



Technical details

load capacity	100.0 kg
opening angle	+/- 90°
hold open	+/- 90°
automatic closing	+/- 80°
glass thickness	8-13.52 mm
temperature resistance	- 15.0 °C to + 40.0 °C
max. door width	1000.0 mm

Finish

satin black anodized (CO 005), imitation satin stainless steel (CO 013), RAL 7016 matt liquid electrostatic coated (CO 059), RAL 9005 matt liquid electrostatic coated (CO 062), RAL 9010 matt liquid electrostatic coated (CO 088), RAL 9016 matt liquid electrostatic coated (CO 095)

Note

i Violent opening further than 95° could unhinge the door. We suggest to install a door stop.

Classification key

EN 1154

3	8	2/5*1	0	1	4
---	---	-------	---	---	---

*1 Please refer to the notes and explanations on page 27.

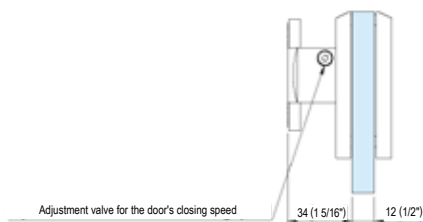
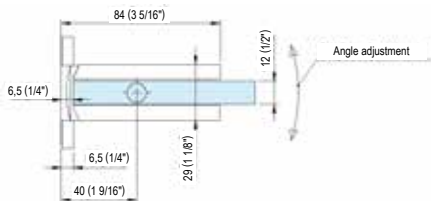
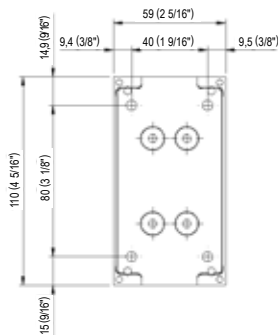
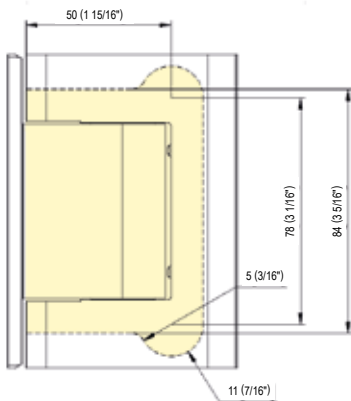

BILOBA

BL 8011

with offset fixing (wall-glass) for double action residential and heavy-duty glass doors

hydraulic hinge **double action door** **up to 100 kg**

Product features

- hydraulic hinge
- for use with wall-glass combinations
- with offset fixing wing
- with closing speed adjustment
- stop at + 90° and - 90°
- automatic closing from + 80° and - 80°
- can also be used for single action doors

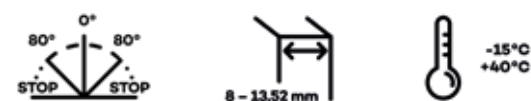

Technical details

load capacity	100.0 kg
opening angle	+/- 90°
hold open	+/- 90°
automatic closing	+/- 80°
thickness	8–13.52 mm
temperature resistance	- 15.0 °C to + 40.0 °C
max. door width	1000.0 mm

Finish

satin black anodized (CO 005), imitation satin stainless steel (CO 013), RAL 7016 matt liquid electrostatic coated (CO 059), RAL 9005 matt liquid electrostatic coated (CO 062), RAL 9010 matt liquid electrostatic coated (CO 088), RAL 9016 matt liquid electrostatic coated (CO 095)

Combination

BL 8011 SF, BL 8011 SOL

Note

i Violent opening further than 95° could unhinge the door. We suggest to install a door stop. For doors with width less than 500 mm use items BL 8011 + BL 8011 SOL.

Classification key

EN 1154

3	8	2/5*1	0	1	4
---	---	-------	---	---	---

*1 Please refer to the notes and explanations on page 27.

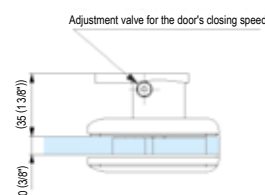
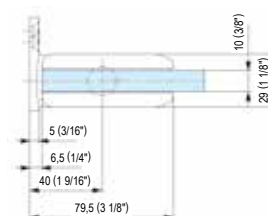
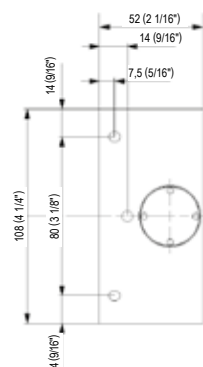
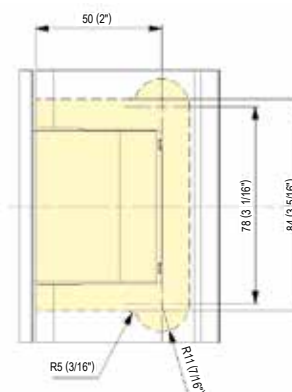

BILOBA

BL 8011 SF

with offset fixing (wall-glass) for double action residential and heavy-duty glass doors without stop

hydraulic hinge	double action door	up to 100 kg
------------------------	---------------------------	---------------------

Product features

- hydraulic hinge
- for use with wall-glass combinations
- with offset fixing wing
- with closing speed adjustment
- automatic closing from +80° and -80°
- can also be used for single action doors

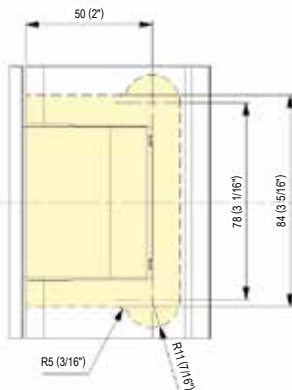

Technical details

load capacity	100.0 kg
opening angle	+/- 90°
automatic closing	+/- 80°
glass thickness	8-13.52 mm
temperature resistance	- 15.0 °C to + 40.0 °C
max. door width	1000.0 mm

Finish

EV1 satin silver natural, anodized 20 micron (CO 002), satin black anodized (CO 005), imitation satin stainless steel (CO 013), polished Chrome (CO 014), imitation matt chrome liquid electrostatic coated (CO 015), polished gold (CO 016), matt gold (CO 017), RAL 9005 matt liquid electrostatic coated (CO 062), RAL 9010 matt liquid electrostatic coated (CO 088), RAL 9016 matt liquid electrostatic coated (CO 095)

Combination

BL 8011

Note

i Violent opening further than 95° could unhinge the door. We suggest to install a door stop.

Classification key

EN 1154

3	8	2/5*1	0	1	4
----------	----------	--------------	----------	----------	----------

*1 Please refer to the notes and explanations on page 27.

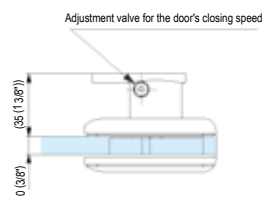
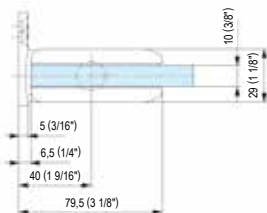
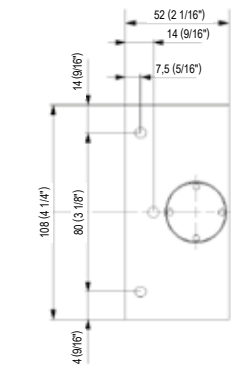

BILOBA

BL 8011 SOL

with offset fixing (wall-glass) for double action residential and heavy-duty glass doors

free hinge	double action door	up to 100 kg
-------------------	---------------------------	---------------------

Product features

- free swinging hinge
- with offset fixing wing
- for use with wall-glass combinations
- can also be used for single action doors

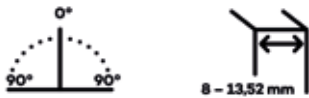

Technical details

load capacity	100.0 kg
opening angle	+/- 90°
thickness	8-13.52 mm
max. door width	1000.0 mm

Finish

EV1 satin silver natural, anodized 20 micron (CO 002), satin black anodized (CO 005), imitation satin stainless steel (CO 013), polished Chrome (CO 014), imitation matt chrome liquid electrostatic coated (CO 015), polished gold (CO 016), matt gold (CO 017), RAL 9005 matt liquid electrostatic coated (CO 062), RAL 9010 matt liquid electrostatic coated (CO 088), RAL 9016 matt liquid electrostatic coated (CO 095)

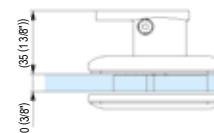
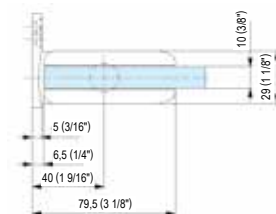
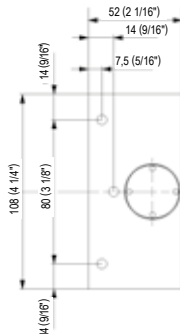
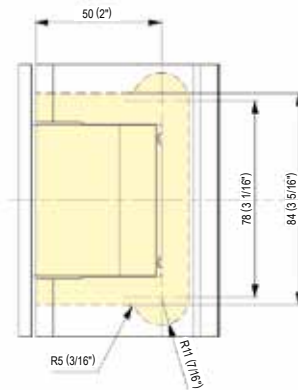

BILOBA

BL 8911

with offset fixing (wall-glass) for double action residential and heavy-duty glass doors

hydraulic hinge	double action door	up to 100 kg
-----------------	--------------------	--------------

Product features

- hydraulic hinge
- with offset fixing wing
- for use with wall-glass combinations
- with closing speed adjustment
- with zero point adjustment
- stop at +90° and -90°
- automatic closing from +80° and -80°
- can also be used for single action doors

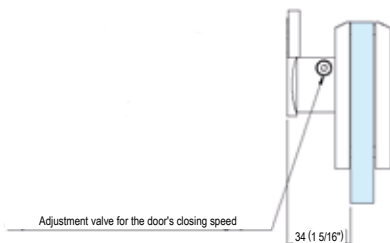
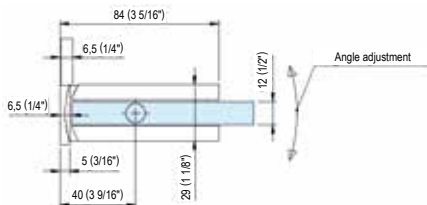
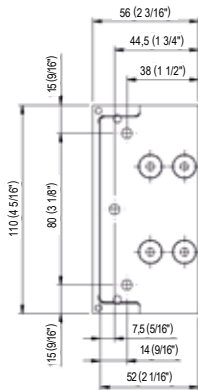
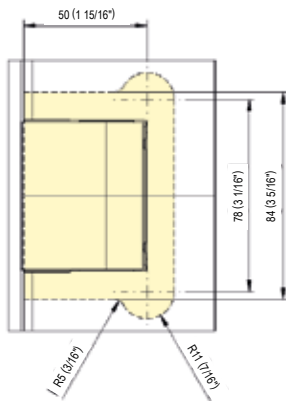

Technical details

load capacity	100.0 kg
opening angle	+/- 90°
hold open	+/- 90°
automatic closing	+/- 80°
glass thickness	8-13.52 mm
temperature resistance	- 15.0 °C to + 40.0 °C
max. door width	1000.0 mm

Finish

satin black anodized (CO 005), imitation satin stainless steel (CO 013), RAL 7016 matt liquid electrostatic coated (CO 059), RAL 9005 matt liquid electrostatic coated (CO 062), RAL 9010 matt liquid electrostatic coated (CO 088), RAL 9016 matt liquid electrostatic coated (CO 095)

Note

i Violent opening further than 95° could unhinge the door. We suggest to install a door stop.

Classification key

EN 1154

3	8	2/5*1	0	1	4
---	---	-------	---	---	---

*1 Please refer to the notes and explanations on page 27.

Quality marks



BILOBA

BL 8015

with central fixing (glass-glass) for double action residential glass doors

hydraulic hinge double action door up to 80 kg

Product features

- hydraulic hinge
- for use with glass-glass combinations
- with closing speed adjustment
- stop at +90° and -90°
- automatic closing from +80° and -80°
- can also be used for single action doors

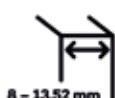
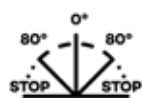

Technical details

load capacity	80.0 kg
opening angle	+/- 90°
hold open	+/- 90°
automatic closing	+/- 80°
thickness	8-13.52 mm
temperature resistance	-15° to +40°
max. door width	1000.0 mm

Finish

EV1 satin silver natural, anodized 20 micron (CO 002), satin black anodized (CO 005), imitation satin stainless steel (CO 013), polished Chrome (CO 014), imitation matt chrome liquid electrostatic coated (CO 015), polished gold (CO 016), matt gold (CO 017), RAL 9005 matt liquid electrostatic coated (CO 062), RAL 9010 matt liquid electrostatic coated (CO 088), RAL 9016 matt liquid electrostatic coated (CO 095)

Combination

BL 8015 SF, BL 8015 SOL, BL 8015 C

Note

i Violent opening further than 95° could unhinge the door. We suggest to install a door stop. For doors with width less than 500 mm use items BL 8015 + BL 8015 SOL. Covers in matt stainless steel and polished stainless steel available on request.

Classification key

EN 1154

3	8	2/5*1	0	1	4
---	---	-------	---	---	---

*1 Please refer to the notes and explanations on page 27.

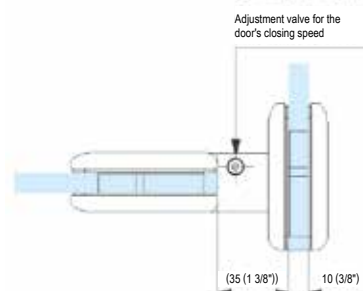
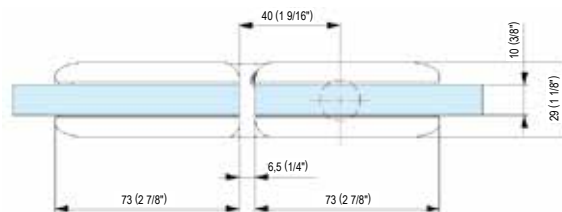
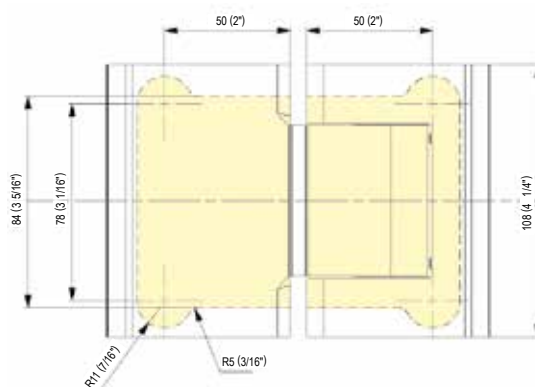

BILOBA

BL 8015 SF

with central fixing (glass-glass) for double action residential glass doors without stop



hydraulic hinge | **double action door** | **up to 80 kg**

Product features

- hydraulic hinge
- for use with glass-glass combinations
- with closing speed adjustment
- automatic closing from +80° and -80°
- can also be used for single action doors

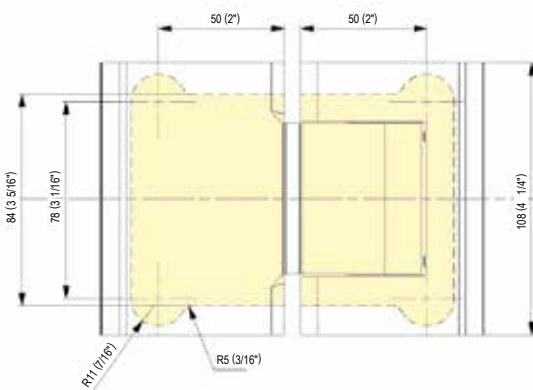

Technical details

load capacity	80.0 kg
opening angle	+/- 90°
automatic closing	+/- 80°
glass thickness	8-13.52 mm
temperature resistance	- 15.0 °C to + 40.0 °C
max. door width	1000.0 mm

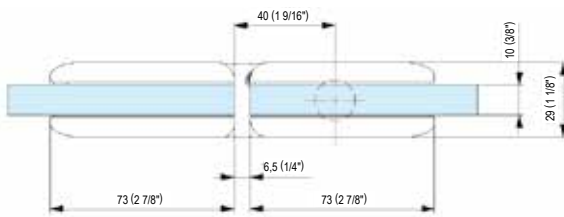

Finish

EV1 satin silver natural, anodized 20 micron (CO 002), satin black anodized (CO 005), imitation satin stainless steel (CO 013), polished Chrome (CO 014), imitation matt chrome liquid electrostatic coated (CO 015), polished gold (CO 016), matt gold (CO 017), RAL 9005 matt liquid electrostatic coated (CO 062), RAL 9010 matt liquid electrostatic coated (CO 088), RAL 9016 matt liquid electrostatic coated (CO 095)

Combination

BL 8015

Note

i Violent opening further than 95° could unhinge the door. We suggest to install a door stop. Covers in matt stainless steel and polished stainless steel available on request.

Classification key

EN 1154

3	8	2/5*1	0	1	4
----------	----------	--------------	----------	----------	----------

*1 Please refer to the notes and explanations on page 27.

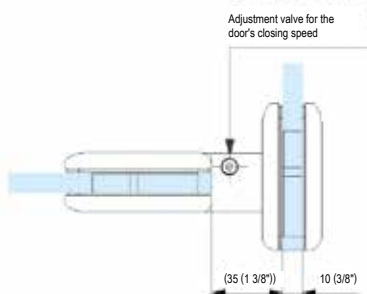

BILOBA

BL 8015 SOL

with central fixing (glass-glass) for double action residential glass doors

free hinge | double action door | up to 80 kg

Product features

- free swinging hinge
- for use with glass-glass combinations
- can also be used for single action doors

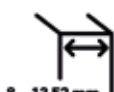

Technical details

load capacity	80.0 kg
opening angle	+/- 90°
thickness	8-13.52 mm
max. door width	1000.0 mm

Finish

EV1 satin silver natural, anodized 20 micron (CO 002), satin black anodized (CO 005), imitation satin stainless steel (CO 013), polished Chrome (CO 014), imitation matt chrome liquid electrostatic coated (CO 015), polished gold (CO 016), matt gold (CO 017), RAL 9005 matt liquid electrostatic coated (CO 062), RAL 9010 matt liquid electrostatic coated (CO 088), RAL 9016 matt liquid electrostatic coated (CO 095)

Combination

BL 8015

Note

i Violent opening further than 95° could unhinge the door. We suggest to install a door stop. Covers in matt stainless steel and polished stainless steel available on request.

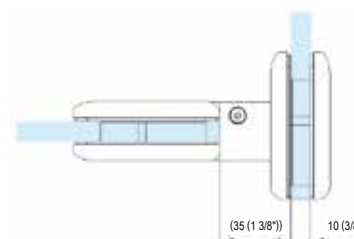
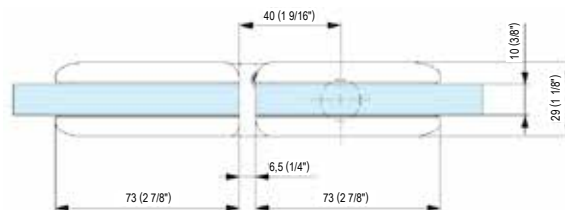
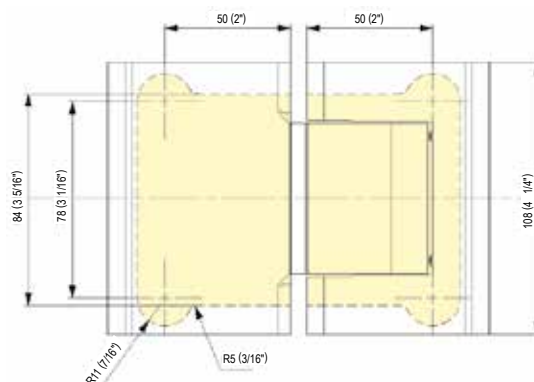



BILOBA

BL 8015 BT JC

with central fixing (glass-glass) for double action residential and shower glass doors with zero point adjustability

hydraulic hinge | **double action door** | **up to 80 kg**

Product features

- hydraulic hinge
- for use with glass-glass combinations
- with closing speed adjustment
- with zero point adjustment
- inner body anodized with special deep oxidation (20 micron)
- stop at +90° and -90°
- automatic closing from +80° and -80°
- version without covers

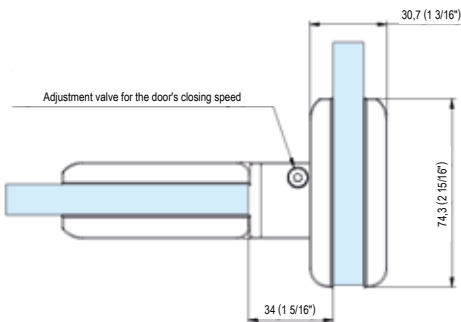
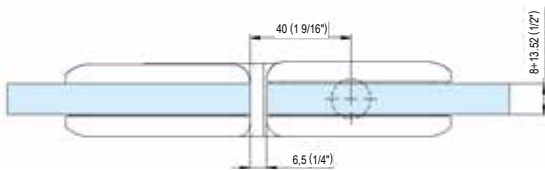
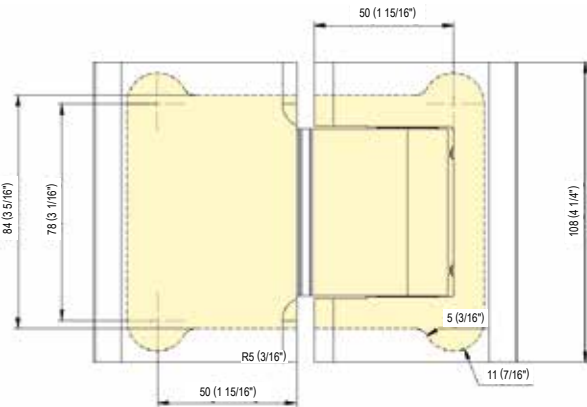

Technical details

load capacity	80.0 kg
opening angle	+/- 90°
hold open	+/- 90°
automatic closing	+/- 80°
thickness	8-13.52 mm
temperature resistance	- 15.0 °C to + 100.0 °C
max. door width	1000.0 mm

Finish

raw (CO 000)

Combination

BL 8015 BT JC C

Note

i Violent opening further than 95° could unhinge the door. We suggest to install a door stop. No Anti-Wind brake. For doors with width less than 500 mm use items BL 8015 BT JC + BL 8015 BT JC SOL. Covers to be ordered separately.

Classification key

EN 1154

3	8	2/5^{*1}	0	1	4
----------	----------	-------------------------	----------	----------	----------

*1 Please refer to the notes and explanations on page 27.



BILOBA

BL 8015 BT JC C

for use with BL 8015 BT JC

cover

Product features

- pair of decorative covers
 - for use with BL 8015 BT JC
-

Finish

polished Chrome (CO 014), brushed stainless steel (CO 031), polished stainless steel (CO 032), RAL 9005 matt liquid electrostatic coated (CO 062), RAL 9016 matt liquid electrostatic coated (CO 095)

Combination

BL 8015 BT JC



BILOBA

BL 8915

with central fixing (glass-glass) for double action residential glass doors

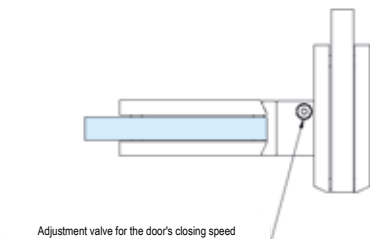
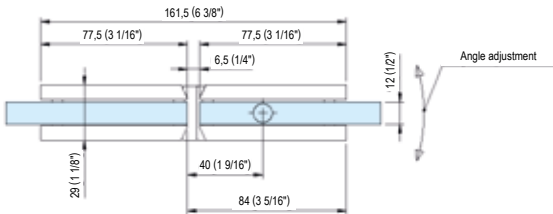
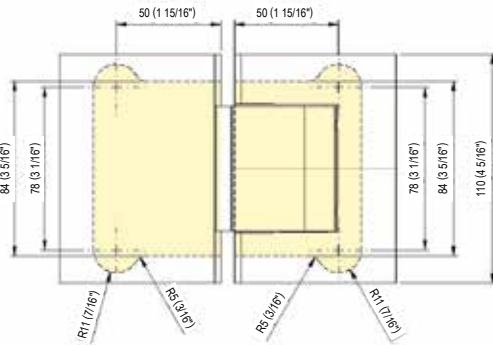

hydraulic hinge	double action door	up to 80 kg
-----------------	--------------------	-------------

Product features

- hydraulic hinge
- for use with glass-glass combinations
- with closing speed adjustment
- with zero point adjustment
- stop at +90° and -90°
- automatic closing from +80° and -80°
- can also be used for single action doors

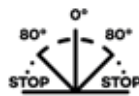

Technical details

load capacity	80.0 kg
opening angle	+/- 90°
hold open	+/- 90°
automatic closing	+/- 80°
thickness	8-13.52 mm
temperature resistance	- 15.0 °C to + 40.0 °C
max. door width	1000.0 mm

Finish

satin black anodized (CO 005), imitation satin stainless steel (CO 013), RAL 7016 matt liquid electrostatic coated (CO 059), RAL 9005 matt liquid electrostatic coated (CO 062), RAL 9010 matt liquid electrostatic coated (CO 088), RAL 9016 matt liquid electrostatic coated (CO 095)

Note

i Violent opening further than 95° could unhinge the door. We suggest to install a door stop.

Classification key

EN 1154

3	8	2/5*1	0	1	4
---	---	-------	---	---	---

*1 Please refer to the notes and explanations on page 27.



BILOBA

BL 8060

with offset fixing (wall-glass) for single action residential and heavy-duty glass doors

hydraulic hinge | **single action door** | **up to 100 kg**

Product features

- hydraulic hinge
- for use with wall-glass combinations
- with offset fixing wing
- with closing speed adjustment
- stop at +90°
- automatic closing from +80°
- can also be used for single action doors

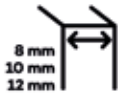

Technical details

load capacity	100.0 kg
opening angle	+ 90°
hold open	+ 90°
automatic closing	+ 80°
glass thickness	8 mm / 10 mm / 12 mm
temperature resistance	- 15.0 °C to + 40.0 °C
max. door width	1000.0 mm

Finish

EV1 satin silver natural, anodized 20 micron (CO 002), satin black anodized (CO 005), imitation satin stainless steel (CO 013), polished Chrome (CO 014), imitation matt chrome liquid electrostatic coated (CO 015), polished gold (CO 016), matt gold (CO 017), RAL 9005 matt liquid electrostatic coated (CO 062), RAL 9010 matt liquid electrostatic coated (CO 088), RAL 9016 matt liquid electrostatic coated (CO 095)

Combination

BL 8060 SF, BL 8060 SOL

Note

i Violent opening further than 95° could unHINGE the door. We suggest to install a door stop. For doors with width less than 500 mm use items BL 8060 + BL 8060 SOL. In case of gasket's usage, consider its overall dimension.

Classification key

EN 1154

3	8	2/5*1	0	1	4
----------	----------	--------------	----------	----------	----------

*1 Please refer to the notes and explanations on page 27.

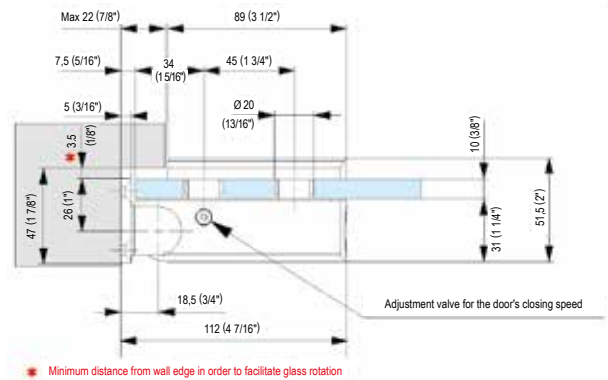
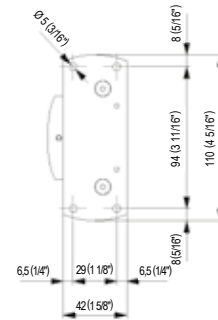
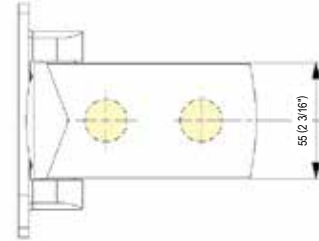

BILOBA

BL 8060 SF

with offset fixing (wall-glass) for single action residential and heavy-duty glass doors without stop

hydraulic hinge	single action door	up to 100 kg
-----------------	--------------------	--------------

Product features

- hydraulic hinge
- for use with wall-glass combinations
- with offset fixing wing
- with closing speed adjustment
- automatic closing from +80°
- can also be used for single action doors

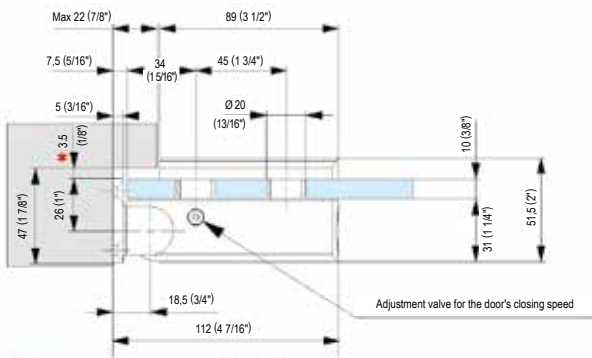
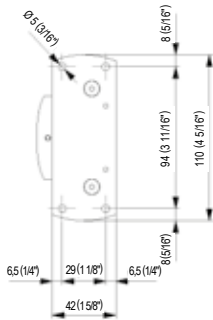
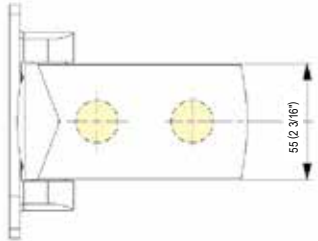
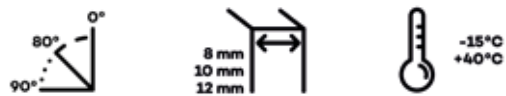

* Minimum distance from wall edge in order to facilitate glass rotation



In case of gasket's usage, consider its overall dimensions.

Technical details

load capacity	100.0 kg
opening angle	+ 90°
automatic closing	+ 80°
glass thickness	8 mm / 10 mm / 12 mm
temperature resistance	- 15.0 °C to + 40 °C
max. door width	1000.0 mm

Finish

satin black anodized (CO 005), imitation satin stainless steel (CO 013), polished Chrome (CO 014), imitation matt chrome liquid electrostatic coated (CO 015), polished gold (CO 016), matt gold (CO 017), RAL 9005 matt liquid electrostatic coated (CO 062), RAL 9010 matt liquid electrostatic coated (CO 088), RAL 9016 matt liquid electrostatic coated (CO 095)

Combination

BL 8060

Note

i Violent opening further than 95° could unhinge the door. We suggest to install a door stop. In case of gasket's usage, consider its overall dimension.

Classification key

EN 1154

3	8	2/5*1	0	1	4
---	---	-------	---	---	---

*1 Please refer to the notes and explanations on page 27.

BILOBA

BL 8060 SOL

with offset fixing (wall-glass) for single action residential and heavy-duty glass doors

free hinge	single action door	up to 100 kg
-------------------	---------------------------	---------------------

Product features

- free swinging hinge
- for use with wall-glass combinations
- with offset fixing wing
- can also be used for single action doors

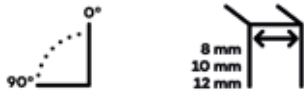

Technical details

load capacity	100.0 kg
opening angle	+ 90°
glass thickness	8 mm / 10 mm / 12 mm
max. door width	1000.0 mm

Finish

EV1 satin silver natural, anodized 20 micron (CO 002), satin black anodized (CO 005), imitation satin stainless steel (CO 013), polished Chrome (CO 014), imitation matt chrome liquid electrostatic coated (CO 015), polished gold (CO 016), matt gold (CO 017), RAL 9005 matt liquid electrostatic coated (CO 062), RAL 9010 matt liquid electrostatic coated (CO 088), RAL 9016 matt liquid electrostatic coated (CO 095)

Note

i In case of gasket's usage, consider its overall dimension.

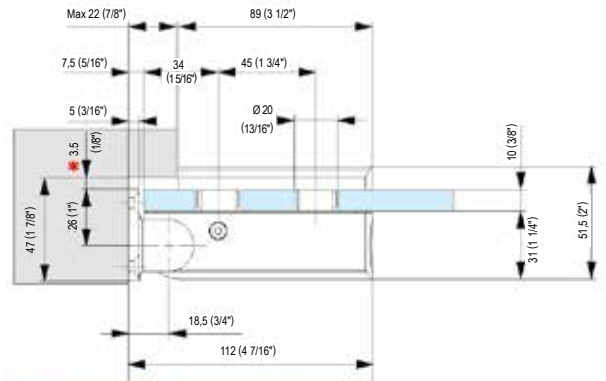
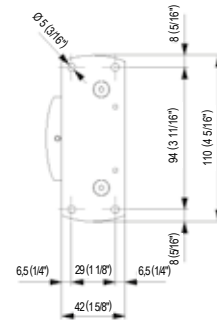
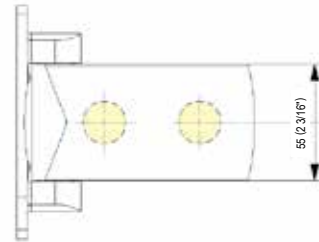

• Minimum distance from wall edge in order to facilitate glass rotation



In case of gasket's usage, consider its overall dimensions.

BILOBA

BL 8060 BT

with offset fixing (wall-glass) for single action shower glass doors

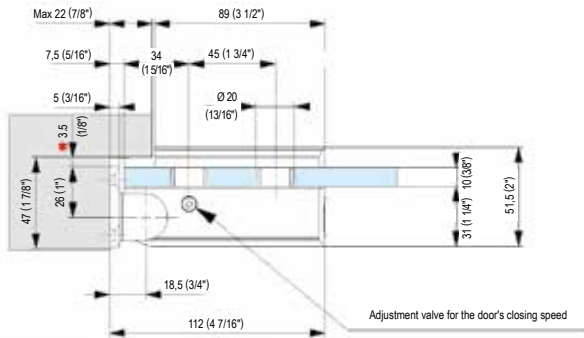
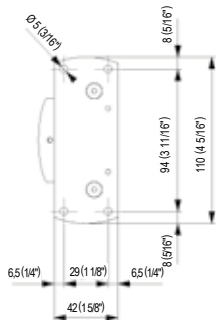
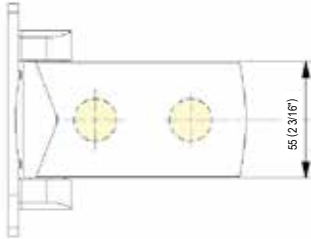

Minimum distance from wall edge in order to facilitate glass rotation

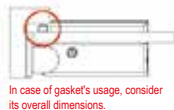

In case of gasket's usage, consider its overall dimensions.

hydraulic hinge	single action door	up to 100 kg
-----------------	--------------------	--------------

Product features

- hydraulic hinge
- for use with wall-glass combinations
- with offset fixing wing
- with closing speed adjustment
- for applications in damp environments and high temperature
- o-rings of the hydraulic circuit are made of Viton
- pivot is made of stainless steel AISI 420
- stop at +90°
- automatic closing from +80°

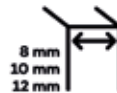

Technical details

load capacity	100.0 kg
opening angle	+ 90°
hold open	+ 90°
automatic closing	+ 80°
glass thickness	8 mm / 10 mm / 12 mm
temperature resistance	- 15.0 °C to + 100.0 °C
max. door width	1000.0 mm

Finish

satin black anodized (CO 005), imitation satin stainless steel (CO 013), polished Chrome (CO 014), imitation matt chrome liquid electrostatic coated (CO 015), polished gold (CO 016), matt gold (CO 017), RAL 9005 matt liquid electrostatic coated (CO 062), RAL 9010 matt liquid electrostatic coated (CO 088), RAL 9016 matt liquid electrostatic coated (CO 095)

Note

i Violent opening further than 95° could unhinge the door. We suggest to install a door stop. The recommended and guaranteed finish for applications in shower enclosures, saunas and Turkish baths is 22 (Deep Oxidation 20 micron). In case of gasket's usage, consider its overall dimension.

Classification key

EN 1154

3	8	2/5*1	0	1	4
---	---	-------	---	---	---

*1 Please refer to the notes and explanations on page 27.

Quality marks



BILOBA

BL 8060 BT SF

with offset fixing (wall-glass) for single action shower glass doors without stop

hydraulic hinge	single action door	up to 100 kg
-----------------	--------------------	--------------

Product features

- hydraulic hinge
- for use with wall-glass combinations
- with offset fixing wing
- with closing speed adjustment
- for applications in damp environments and high temperature
- o-rings of the hydraulic circuit are made of Viton
- pivot is made of stainless steel AISI 420
- automatic closing from +80°

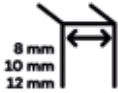
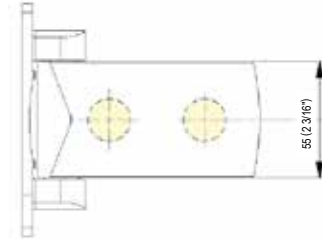

Technical details

load capacity	100.0 kg
opening angle	+ 90°
automatic closing	+ 80°
glass thickness	8 mm / 10 mm / 12 mm
temperature resistance	- 15.0 °C to + 100.0 °C
max. door width	1000.0 mm

Finish

satın black anodized (CO 005), imitation satin stainless steel (CO 013), polished Chrome (CO 014), imitation matt chrome liquid electrostatic coated (CO 015), polished gold (CO 016), matt gold (CO 017), RAL 9005 matt liquid electrostatic coated (CO 062), RAL 9010 matt liquid electrostatic coated (CO 088), RAL 9016 matt liquid electrostatic coated (CO 095)

Combination

BL 8060 SF, BL 8060 SOL

Classification key

EN 1154

3	8	2/5*1	0	1	4
---	---	-------	---	---	---

*1 Please refer to the notes and explanations on page 27.

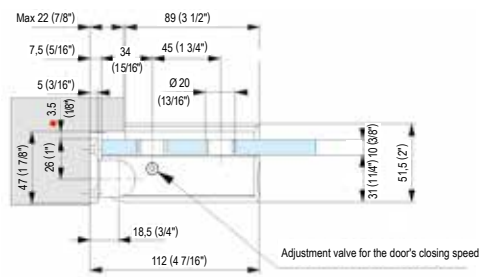
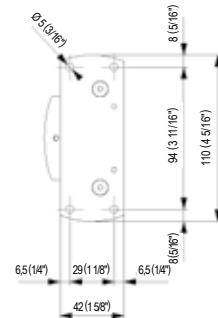

• Minimum distance from wall edge in order to facilitate glass rotation

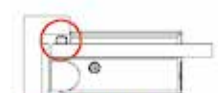

In case of gasket's usage, consider its overall dimensions.

Explanations

General explanations on the classification key used in accordance with EN 1154:2006 for door closing devices with controlled closing sequence:

Our self-closing hinge systems are tested and certified in accordance with the EN 1154:2006 standard. As the European standard does not cover all products available on the market for closing doors with a controlled closing sequence, the European standard is not applicable in all respects to self-closing door hinges. Due to their small size, the torques to be achieved deviate from EN 1154:2006 depending on the door dimensions. The third digit of the certification key is therefore split:

The front digit indicates the torques achieved and the efficiency in accordance with EN 1154:2006, the rear digit indicates the maximum door weight in accordance with EN 1154:2006. All other technical characteristics are specified in the technical data sheets.

The closing forces can be influenced by the type of application design by using one to three door hinges with hydraulic closing function per door and eventually add door hinges without hydraulic closing function.

Finishes

Standard finishes



EV1 satin silver natural, anodized 20 micron (CO 002)



Satin black anodized (CO 005)



Imitation satin stainless steel (CO 013)



polished Chrome (CO 014)

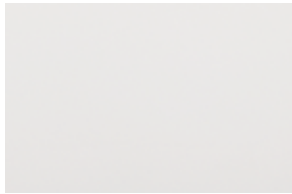

Imitation matt chrome liquid electrostatic coated (CO 015)

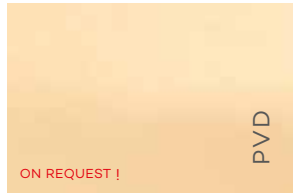

polished gold (CO 016)

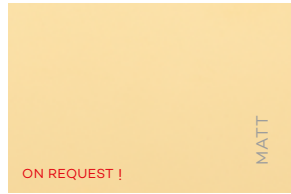

matt gold (CO 017)



Brushed stainless steel (CO 031)



Polished stainless steel (CO 032)

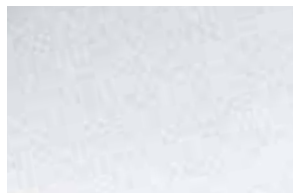

Polished (CO 047)

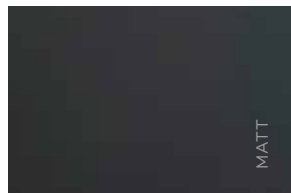

RAL 9005 matt liquid electrostatic coated (CO 062)

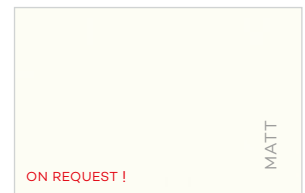

RAL 9005 matt liquid electrostatic coated (CO 088)

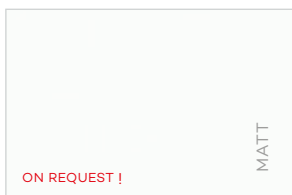

RAL 9016 matt liquid electrostatic coated (CO 095)



COL02 | Finish Folder

Special finishes



Polished bright bronze (CO 066)



Satin mat bronze (CO 067)



Polished bright champagne (CO 068)



Satin mat champagne (CO 069)

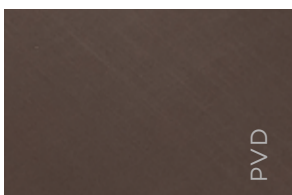

Polished bright gunmetal grey (CO 070)



Satin mat gunmetal grey (CO 071)



RAL | Liquid electrostatic coated



COL03 | Special Finish Folder

PVD – Physical Vapour Deposition

Metal coating that ensures: exceptional resistance to abrasion, resistance to oxidation, innovative and durable colouring.

Ask our sales dept for minimum order, for a quotation and delivery time.

Service – comprehensive expertise for your daily work

We are happy to provide you with all the documentation you need to determine the most suitable hinge system for your building project. Please contact us: we would be delighted to work with you to choose the best solution – from high-quality standard elements right up to the most complex solutions.

All our brochures and data sheets can be requested in a printed version, or you can simply download them on the spot.

Our friendly and knowledgeable application engineers will be pleased to help you and advise you.

www.simonswerk.com

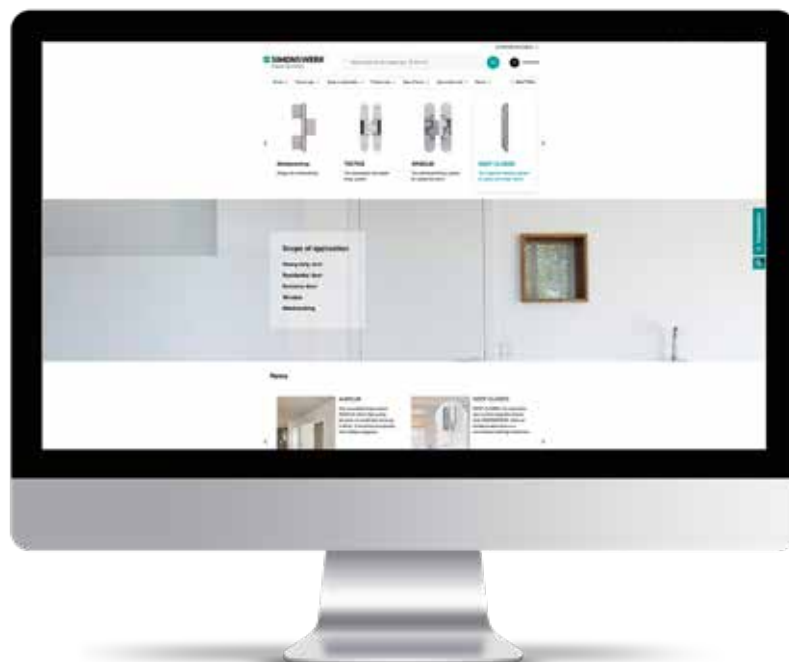

SIMONSWERK GROUP – excellence in product and service

As an internationally operating group of companies, the SIMONSWERK GROUP is the market leader in the area of high-quality hinge systems. With over 900 employees worldwide, we stand for the highest quality standards, constant willingness to innovate and long-lasting customer relationships.

The SIMONSWERK brand combines the entire expertise in hinge systems and unites technical know-how with design standards at the highest level. In addition to innovative product solutions, we offer our customers the best service exactly where it is needed. From personal customer consultations and competent training courses to customised delivery and logistics processes or digital service tools.

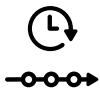

Over 130 years of experience

The perfect foundation for continuous growth with experience



Internationally successful

As the market leader, we are constantly expanding our know-how



Over 900 employees worldwide

Every single employee shapes the vision of the SIMONSWERK GROUP



Focused product solutions

With high-quality hinge systems for heavy-duty, residential and entrance doors, we offer product solutions for all applications and materials

For our customers and partners

As SIMONSWERK GROUP, we are active in a variety of business models. Both in the construction project business and in cooperation with door manufacturers as well as with hardware dealers and processors, we develop perfect solutions, depending on individual market needs. We will provide our customers and decision-makers with the best possible support as a partner in accordance with their various requirements.



SIMONSWERK

BILOBA

The self-closing screw-on hinge system for glass doors

SIMONSWERK GmbH

Bosfelder Weg 5
33378 Rheda-Wiedenbrück
Germany

+49 5242 4130

info@simonswerk.de

www.simonswerk.de

Member of the

**SIMONSWERK
GROUP**

© SIMONSWERK GmbH
01/2024, 5 800600 0 00001/20
Subject to technical modifications.

